

# SPECIFICATIONS

## ZAXIS 350LC 25 m

### WORKING RANGES

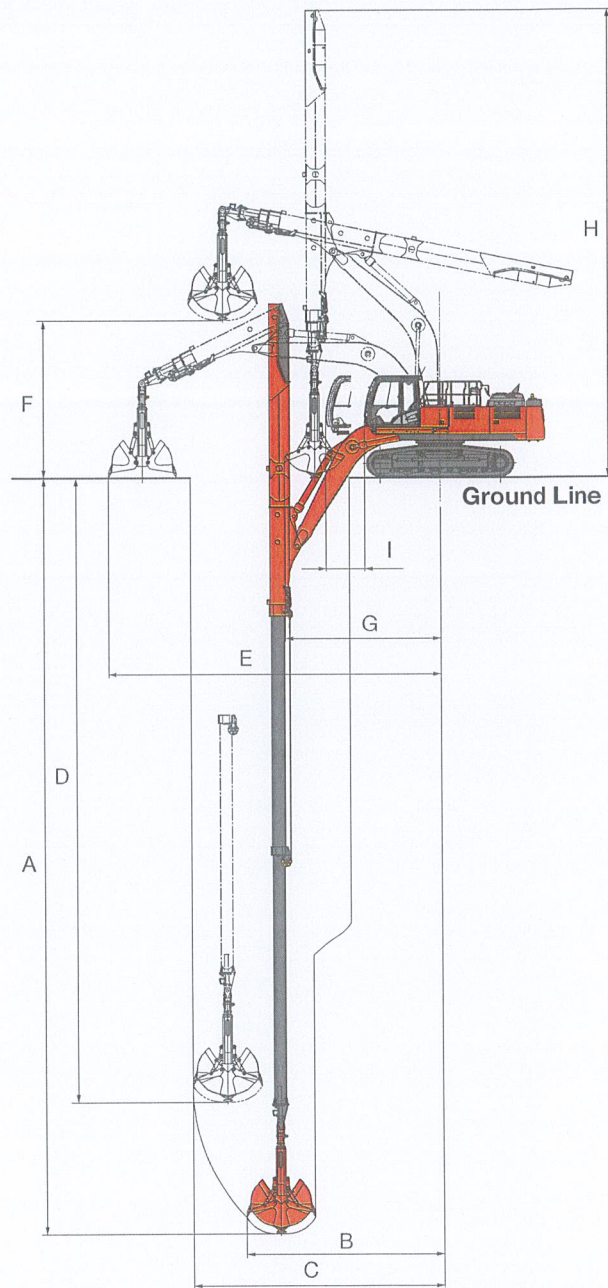

Unit: mm

Model	ZX350LC-6	ZX350LCN-6
Telescopic arm type	S-TC300R-7	
Telescopic arm system	Hydraulic cylinder + wire rope	
A Max. vertical digging depth	25 200	25 160
B Radius at max. vertical digging depth	6 630	6 570
C Max. vertical digging radius	8 380	8 330
D Depth at max. vertical digging radius	20 750	20 700
E Max. working radius	11 140	11 090
F Max. dumping height	5 330	5 380
G Min. front swing radius	5 230	5 180
H Height at min. front swing radius	15 660	
I Cab sliding distance	1 300	

# SPECIFICATIONS

## ZAXIS 350LC 25 m

### DIMENSIONS

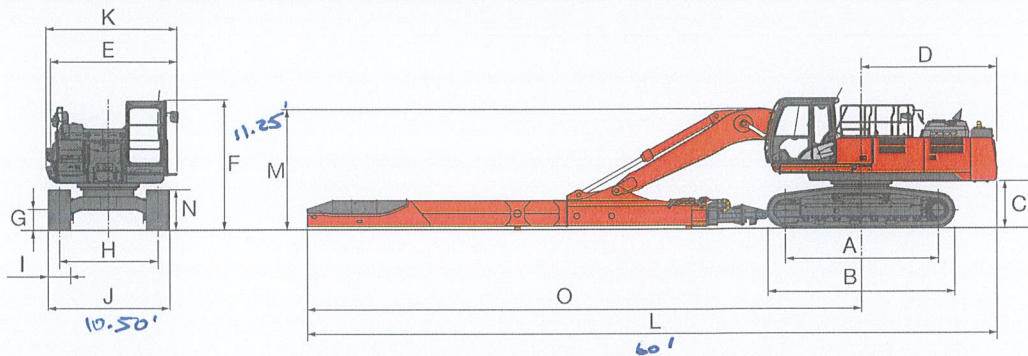

Unit: mm

	ZX350LC-6	ZX350LCN-6
A Distance between tumblers	4 050	
B Undercarriage length	4 940	
*C Counterweight clearance	1 160	
D Rear-end swing radius	3 600	
E Overall width of upperstructure	3 290	
F Overall height of cab	Folding the Step: 3 060	
*G Min. ground clearance	500	
H Track gauge	2 590	2 390
I Track shoe width	G 600	
J Undercarriage width	3 190	2 990
K Overall width	3 390	3 290
L Overall length	Folding the Step: 3 160	
M Overall height of boom	18 150	
N Track height with triple grouser shoes	3 250	
O Swing centre to front distance	1 070	
	14 570	

\* Excluding track shoe lug G: Triple grouser shoe

### TRANSPORTATION

TOTAL WT = 89,926 LBS.

Unit: mm

	ZX350LC-6	ZX350LCN-6
Width:	3 190 mm	2 990 mm
Weight: (With Sliding cab)	25 510 kg 56,240	25 450 kg

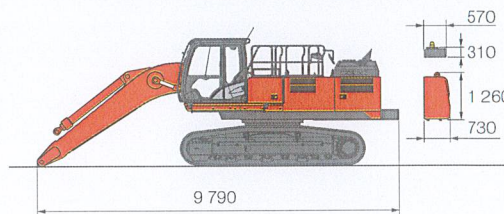

	ZX350LC-6	ZX350LCN-6
Counterweight		
Width:	2 950 mm	2 950 mm
Weight:	7 600 kg	7 600 kg
Additional counterweight		
Width:	2 780 mm	2 780 mm
Weight:	2 230 kg	2 230 kg

#### Telescopic Arm

##### ZX350LC-6

Width: 760 mm Weight: 5 450 kg = 12,015

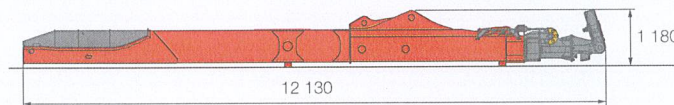

#### Clamshell Bucket

21,671

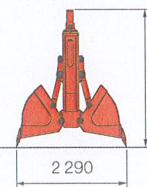

9.25'  
Width: 1 270 mm  
Weight: 2 000 kg  
4,410 LBS.

##### ZX350LCN-6

Width: 760 mm Weight: 5 450 kg

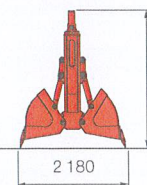
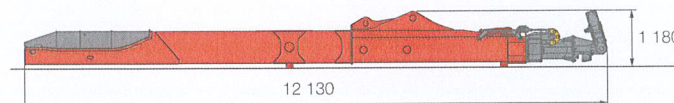

Width: 1 270 mm  
Weight: 1 970 kg